

Product Name:	Cryo Boxes
Product Application:	For centralized placement of cryogenic vials.
Product Materials:	PC (cap) + ABS (bottom)
product Specifications:	Temperature range: stored at room temperature Shelf life: 5 Years after date of production (ensure package is in good)
Sterilization:	No
BSE/TSE:	These products are deemed animal free.
Performance Testing:	Each manufacturing lot is sampled and tested in accordance with standard operating procedures. Appearance inspection: pass Packaging inspection: pass
Features	<ol style="list-style-type: none"> 1. The cap is made of polycarbonate plastic (PC), and the bottom is made of acrylonitrile butadiene styrene plastic (ABS). 2. Clear polycarbonate cover for easy identification. 3. Individually packed. 4. Alphanumeric grid for easy sample identification. 5. Each box includes drain holes and air vents to minimize condensation. 6. Withstand temperature range: Approx.-196°C to 121°C.

Product Range

Cryogenic Box

Cat. No.	Product Description	/Pack	/Case
616651	For 1.5 ml vials	10*10	14
616051	For 2.0 ml vials	10*10	12
616151	For 4.0 ml vials	10*10	8
616551	For 5.0 ml vials	10*10	6
616041	For 2.0 ml vials	8*6	10
616841	For 6.0 ml vials	6*4	10

Head Office No. 530, Xida Road, Meicun Industrial Park, Xinwu District, Wuxi, Jiangsu, China
Tel: +86+ 510-6800 6788 Email: info@nest-wuxi.com
Online: www.cell-nest.com

Oversea NEST USA (New Jersey/ Phoenix)
NEST scientific 株式会社 (Yokohama, Japan)
NEST Scientific Europe B.V (Netherlands)
Nest Scientific (MENA) FZE (Sharjah, United Arab Emirates)

Cap Inserts

Cat. No.	Color	Sterilization	/Pack	/Case
611201	White	No	100	1000
611202	Red	No	100	1000
611203	Yellow	No	100	1000
611204	Blue	No	100	1000
611205	Green	No	100	1000
611206	Purple	No	100	1000

Note:

New Cap Inserts are compatible with new cryogenic tubes.

New Cap Inserts do not match 1ml, 0.75ml, 0.5ml cryogenic tubes, but all other sizes do.

Technical Drawing

Cap Inserts

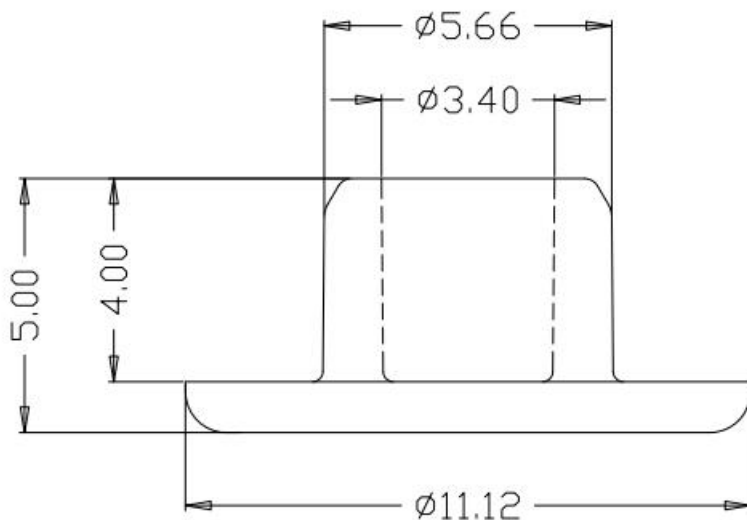

Head Office No. 530, Xida Road, Meicun Industrial Park, Xinwu District, Wuxi, Jiangsu, China
 Tel: +86+ 510-6800 6788 Email: info@nest-wuxi.com
 Online: www.cell-nest.com

Oversea NEST USA (New Jersey/ Phoenix)
 NEST scientific 株式会社 (Yokohama, Japan)
 NEST Scientific Europe B.V (Netherlands)
 Nest Scientific (MENA) FZE (Sharjah, United Arab Emirates)

Product Picture

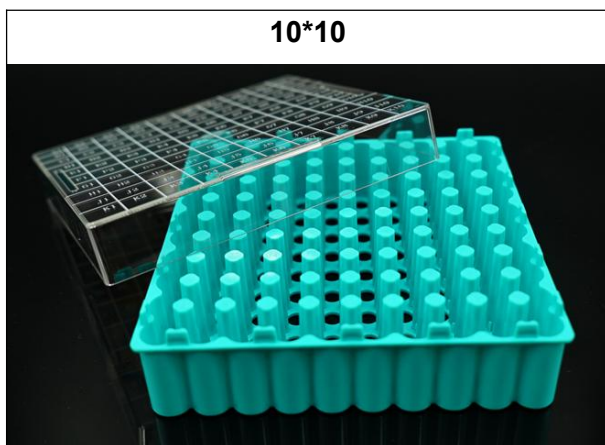

Technical Drawing

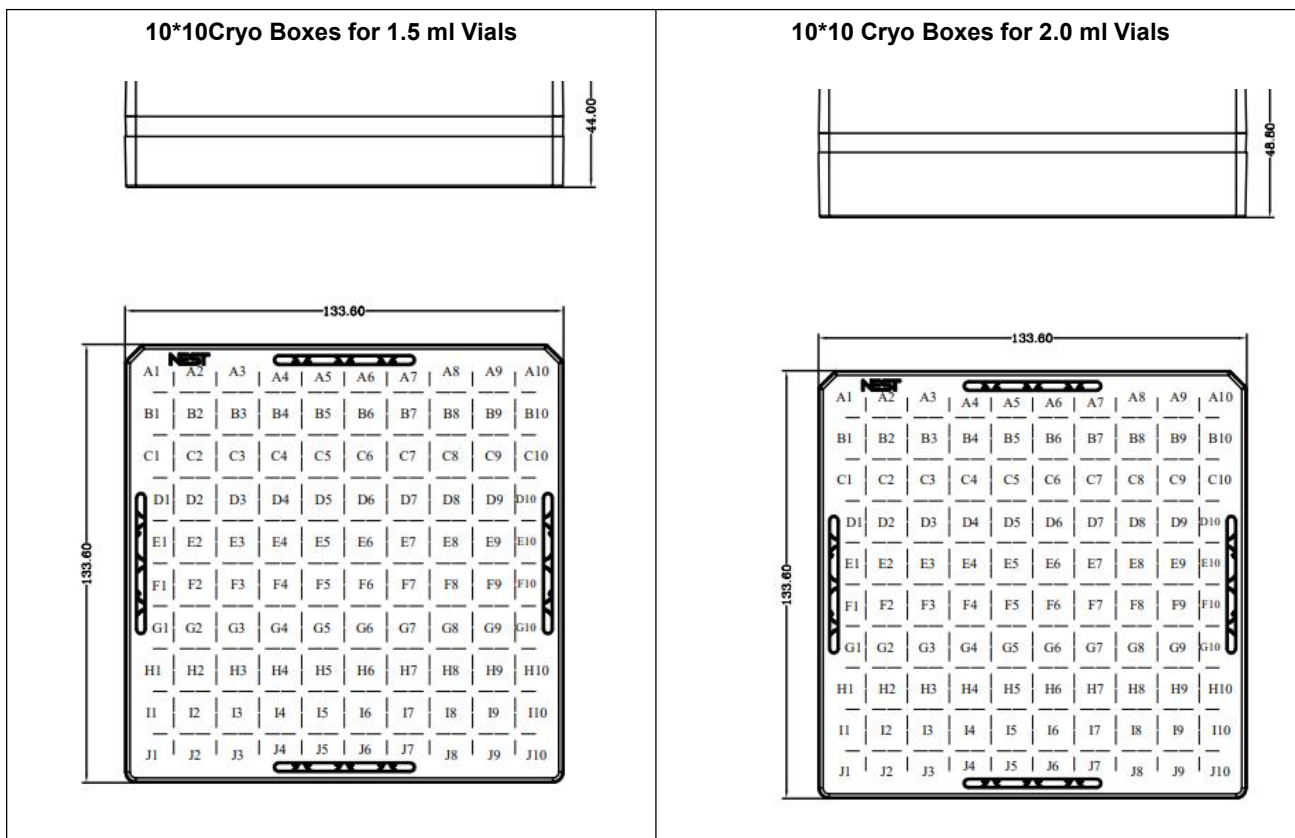

Head Office No. 530, Xida Road, Meicun Industrial Park, Xinwu District, Wuxi, Jiangsu, China
 Tel: +86+ 510-6800 6788 Email: info@nest-wuxi.com
 Online: www.cell-nest.com

Oversea NEST USA (New Jersey/ Phoenix)
 NEST scientific 株式会社 (Yokohama, Japan)
 NEST Scientific Europe B.V (Netherlands)
 Nest Scientific (MENA) FZE (Sharjah, United Arab Emirates)

ISO9001 & ISO13485 & ISO11137

10*10 Cryo Boxes for 4.0 ml Vials

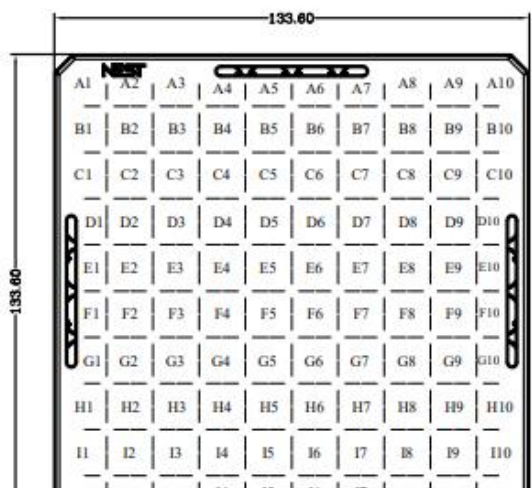

10*10 Cryo Boxes for 5.0 ml Vials

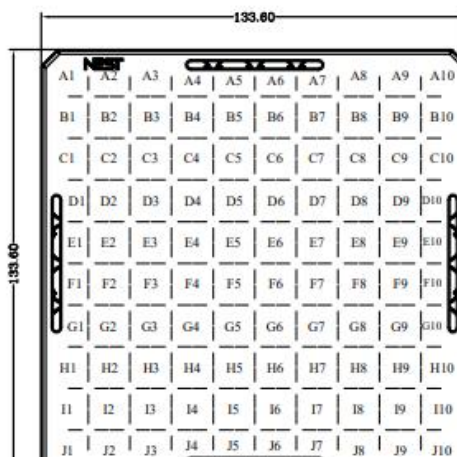

8*6 Cryo Boxes for 2.0 ml Vials

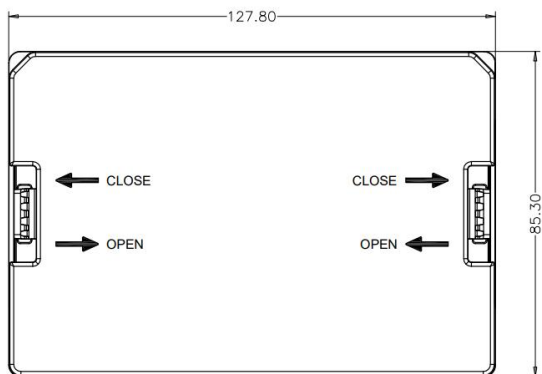
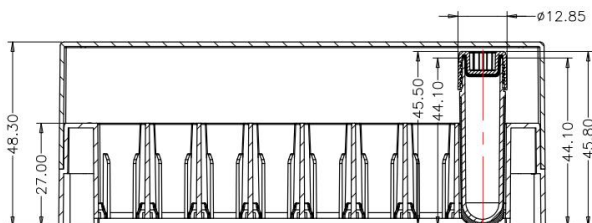

6*4 Cryo Boxes for 6.0 ml Vials

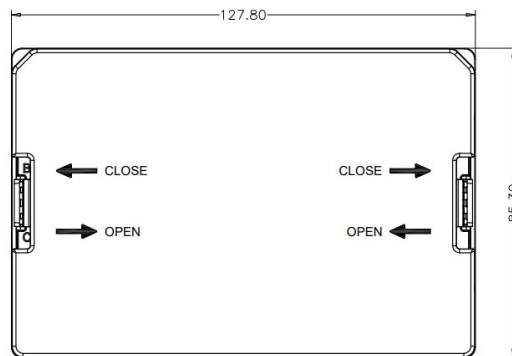
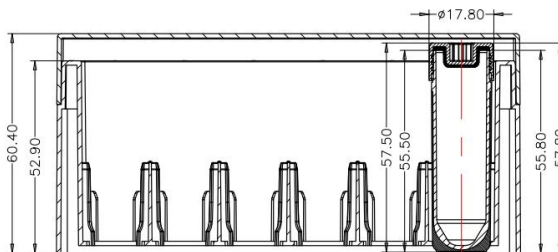

Head Office No. 530, Xida Road, Meicun Industrial Park, Xinwu District, Wuxi, Jiangsu, China
 Tel: +86+ 510-6800 6788 Email: info@nest-wuxi.com
 Online: www.cell-nest.com

Oversea NEST USA (New Jersey/ Phoenix)
 NEST scientific 株式会社 (Yokohama, Japan)
 NEST Scientific Europe B.V (Netherlands)
 Nest Scientific (MENA) FZE (Sharjah, United Arab Emirates)